



NERO AB5 Active Studio Monitor

The AB5 works perfectly in any listening environment, whether home office/studio, gaming, large or small production facilities, with absolute clarity. It delivers accurate monitoring and provides the listener with a neutral tool to enjoy or create recordings that optimize the clarity.

The AB5 features a dedicated internal DSP that optimizes phase, frequency response and dynamics. This makes the sound more accurate and transients more vivid and detailed, while at the same time improving the dynamics and the natural timbre of the sound.

FEATURES

- Woofer: 5.25" Composite Fiberglass Woofer
- Tweeter: 1" ferrofluid cooled Soft Dome tweeter
- Power: 75W + 25W Class-D Amplifiers
- Freq Response: 50Hz-20kHz
- 0° Phase Response
- OSD Precision Waveguide
- DSP Processing
- Low distortion frontal Vented Ports
- Cabinet: Front Inverted W/ Transparent Fabric Grille & 3M® EVA Antivibration Pad
- Color: Black
- Dimensions: 185 x 300 x 243 mm 7.28 x 11.8 x 9.57 in.
- Warranty: 2 Years
- Sold as Singles



NERO AB5 Active Studio Monitor

TECHNICAL SPECIFICATIONS

Acoustical specifications	Frequency Response:	50 Hz ÷ 20000 Hz
	Max SPL @ 1m:	107 dB
	Horizontal coverage angle:	110°
	Vertical coverage angle:	70°
Transducers	Dome Tweeter:	1.0" neo, 1.0" v.c
	Woofers:	5.0"
Input/Output section	Input signal:	bal/unbal
	Input connectors:	XLR, Jack, RCA
	Input sensitivity:	-2 dBu
Processor section	Crossover Frequencies:	2000Hz
	Limiter:	Soft Limiter
Power section	Total Power:	200 W Peak, 100 W RMS
	High frequencies:	50 W Peak, 25 W RMS
	Low frequencies:	150 W Peak, 75 W RMS
	Connections:	XLR, Jack, RCA
Standard compliance	CE marking:	Yes
Physical specifications	Cabinet/Case Material:	MDF
	Color:	Black - RAL 9005
Size	Height:	300 mm / 11.81 inches
	Width:	185 mm / 7.28 inches
	Depth:	243 mm / 9.57 inches
	Weight:	4.3 kg / 9.48 lbs
Shipping informations	Package Height:	400 mm / 15.75 inches
	Package Width:	339 mm / 13.35 inches
	Package Depth:	261 mm / 10.28 inches
	Package Weight:	6 kg / 13.23 lbs

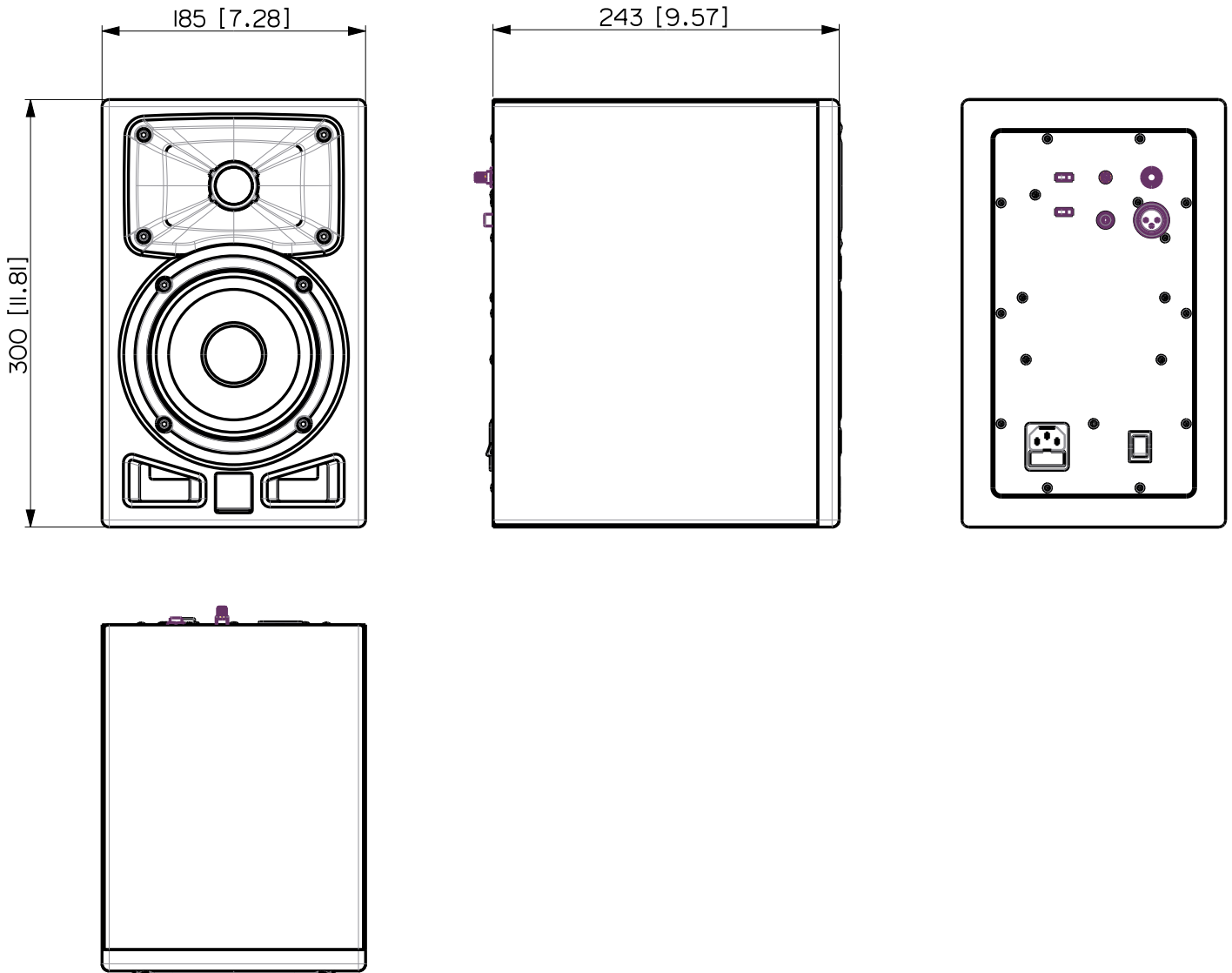

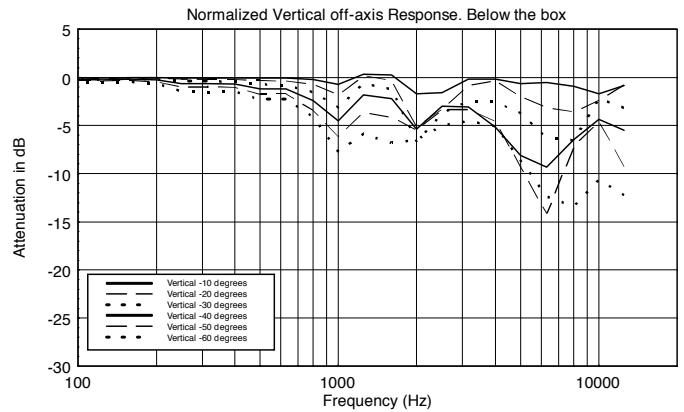
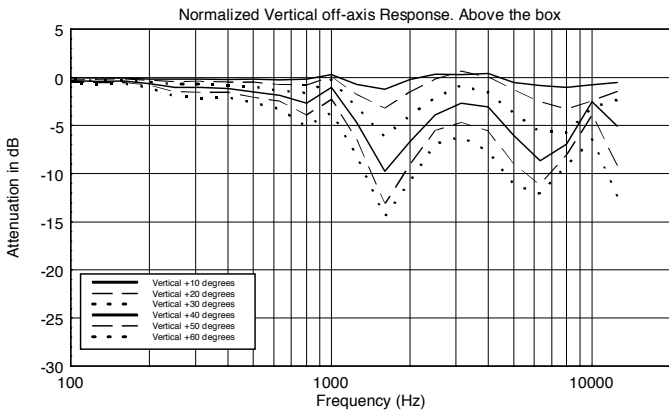
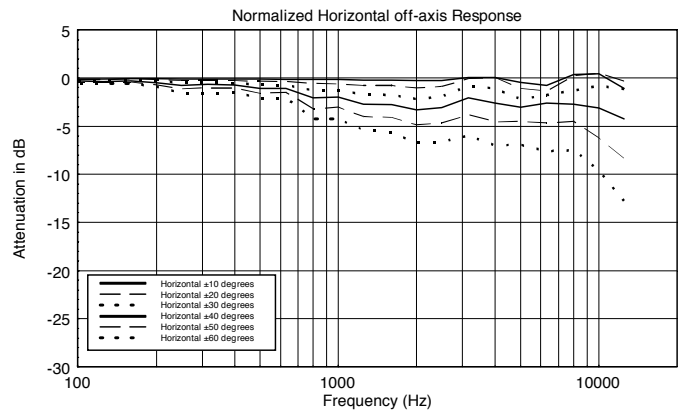
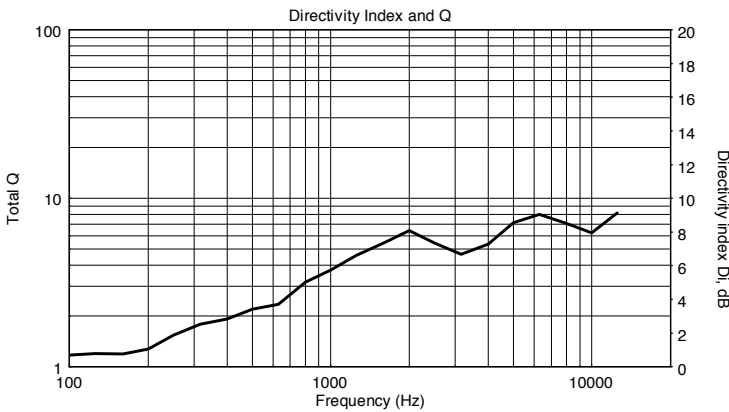
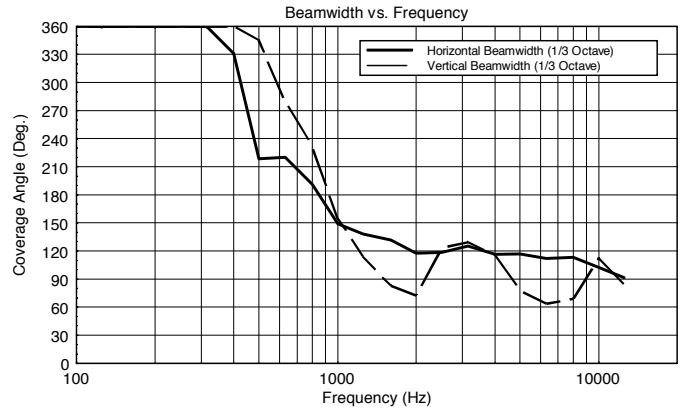
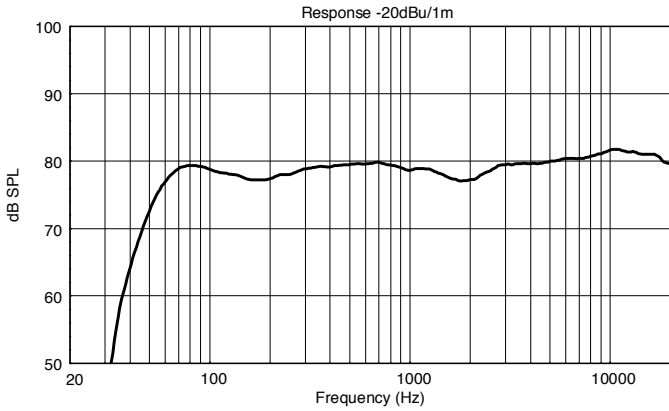

Horizontal 1/3 Octave Polars

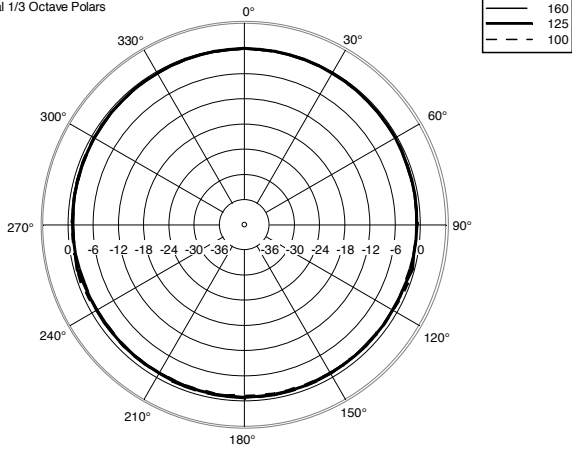

Horizontal 1/3 Octave Polars

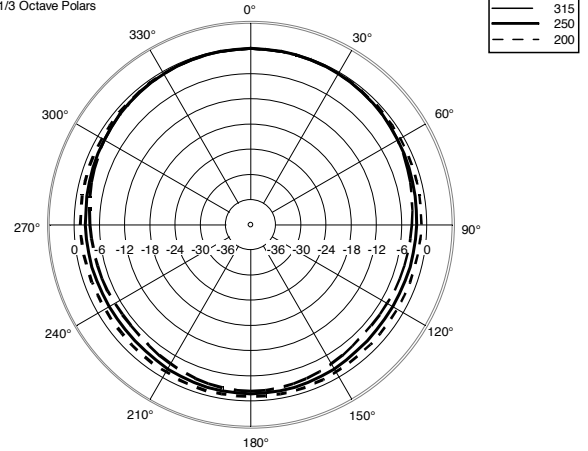

Horizontal 1/3 Octave Polars

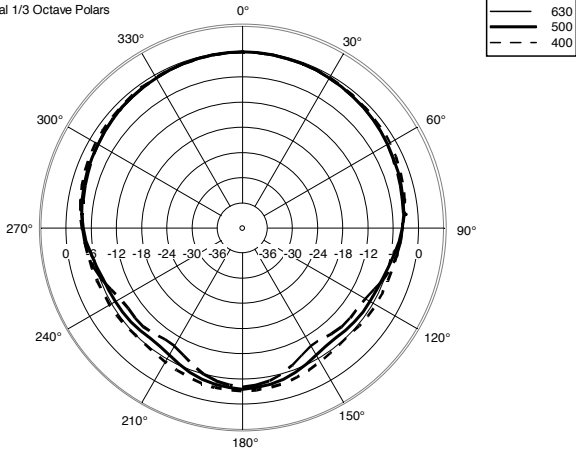

Horizontal 1/3 Octave Polars

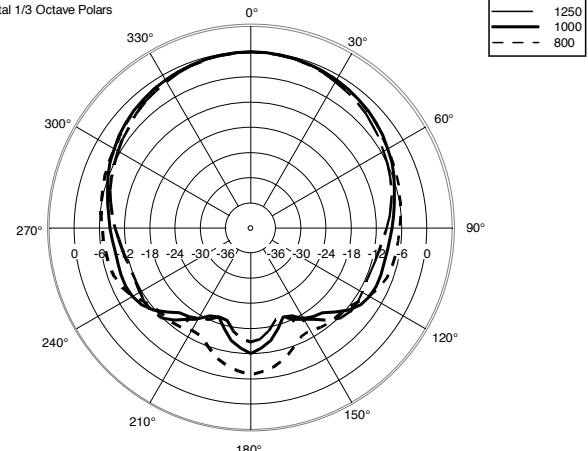

Horizontal 1/3 Octave Polars

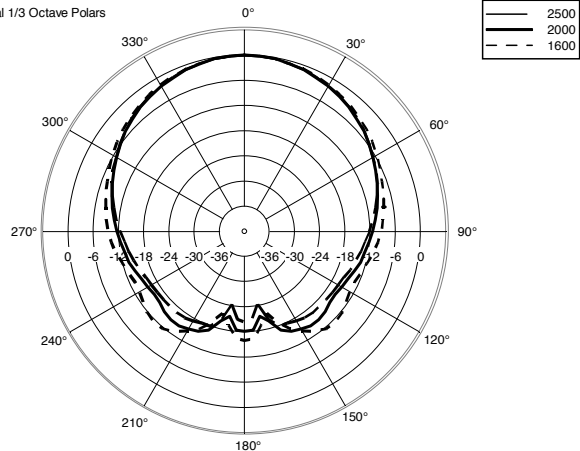

Horizontal 1/3 Octave Polars

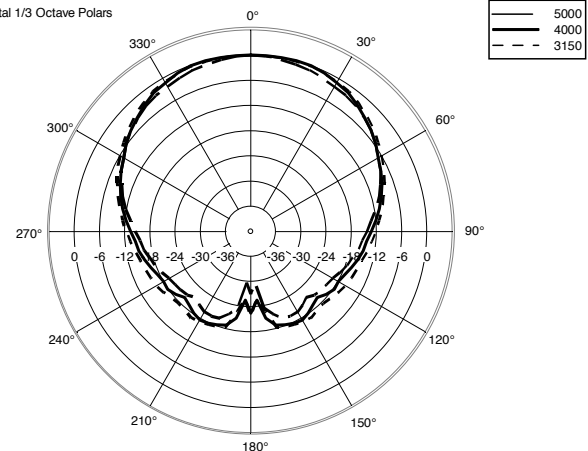

Vertical 1/3 Octave Polars

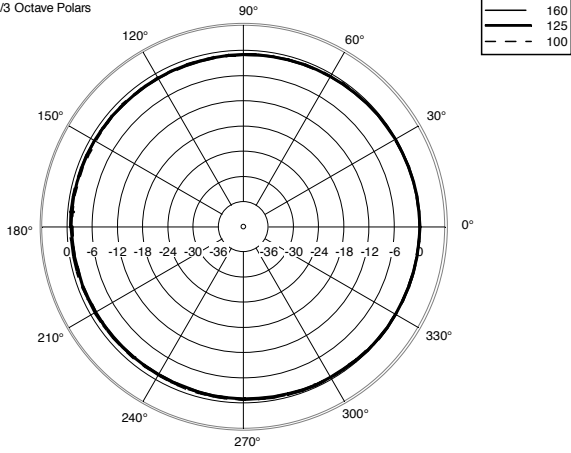

Vertical 1/3 Octave Polars

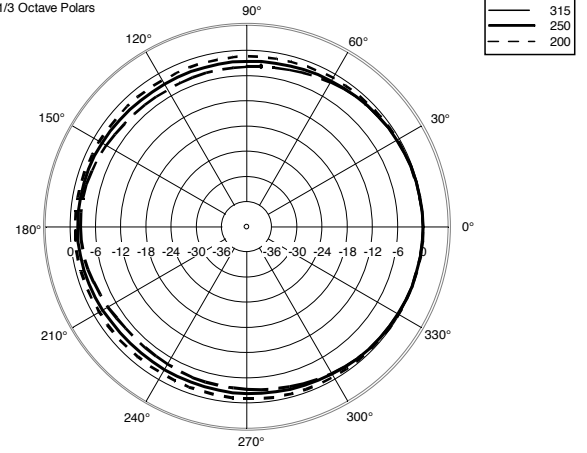

Vertical 1/3 Octave Polars

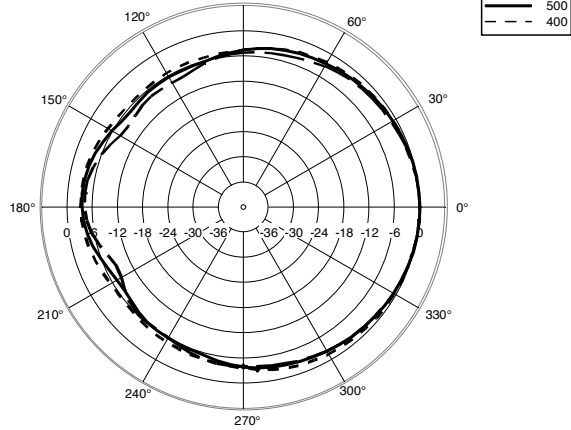

Vertical 1/3 Octave Polars

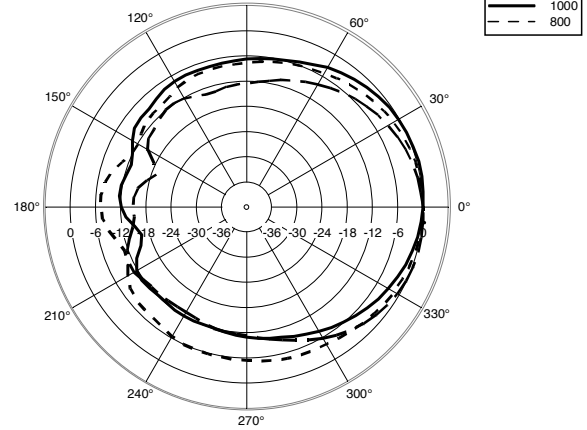

Vertical 1/3 Octave Polars

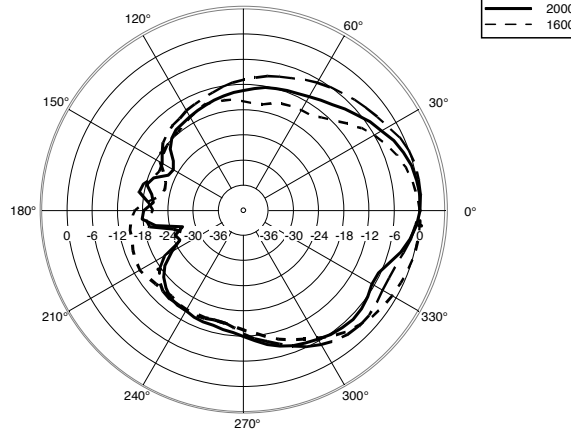

Vertical 1/3 Octave Polars

